



## Pneumatic Control Valves

Force Control's family of **Oil Shear Clutch and Brake Products** is most often actuated by a **Pneumatic Control Valve**. Torque control of the units is accomplished by adjusting the actuation pressure. To aid the designer in the selection specification of the correct control circuit the charts below have been provided. During the selection process of the Posidyne or Posistop a particular logic type was decided upon. Based on the logic type of your unit find the correct control valve model number indicated in the appropriate chart.

### Valves—Posidyne Clutch Brake

Valve Model Number				
Logic	Standard Clutch Brake			X Class
	Size 02-10	Size 11	Size 20 & 30	
S	2PC-3/8 or 2PI-3/8	2PI-5/8	2PI-3/4	N/A
SA	2PC-3/8 or 2PI-3/8	2PI-5/8	2PI-3/4	N/A
A	1PC-3/8 or 2PI-3/8*	2PI-5/8*	2PI-3/4*	1PC-1/8 or 1PI-3/8
B	1PC-3/8 or 2PI-3/8*	2PI-5/8*	2PI-3/4*	N/A
C	1PC-3/8 or 2PI-3/8*	2PI-5/8*	2PI-3/4*	1PC-1/8 or 1PI-3/8
SCP	2PC-SC-3/8	2PC-SC-5/8	2PC-SC-3/4	N/A
P	2PC-3/8 or 2PI-3/8	2PI-5/8	2PI-3/4	2PI-1/8

NA=Not Available

\* When using a Model 2PI for an A, B, or C Logic Clutch Only Unit the brake port must be plugged.

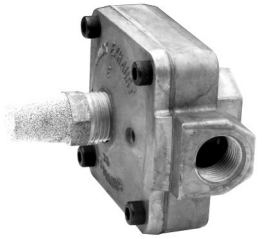

### Valves—Posistop Brake

Logic	Valve Model Number	
	MB Series Posistop	XB Class Brake
S	1PI-Br-3/8 or 1PC-3/8	1PI-Br-1/8 or 1PC-1/8
SA	2PC-3/8 or 2PI-3/8	2PI-5/8
A	1PC-3/8 or 2PI-3/8	2PI-5/8

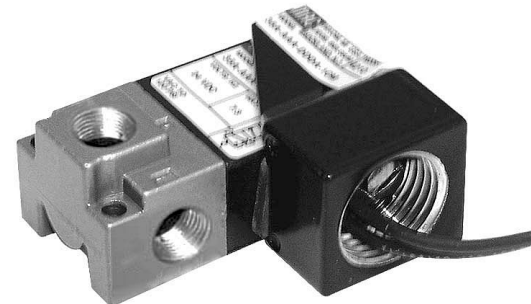
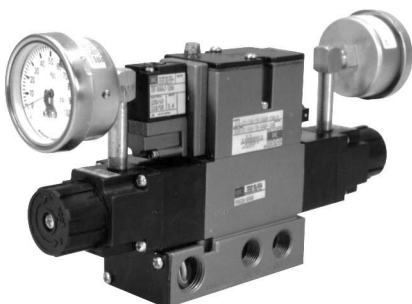



Force Control Industries, Inc.  
 3660 Dixie Highway Fairfield, Ohio 45014 USA  
 Phone: 513-868-0900 Fax: 513-868-2105

# Pneumatic Control Valves

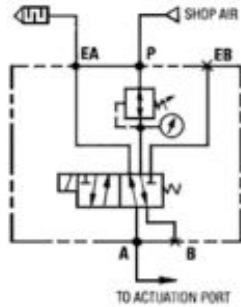

### 1PC-3/8 Remote Mounted

Two position, four way, five ported, single solenoid, spring return, with single pressure sandwich regulator sub-base mounted, 3/8" NPT.

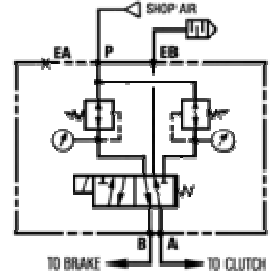
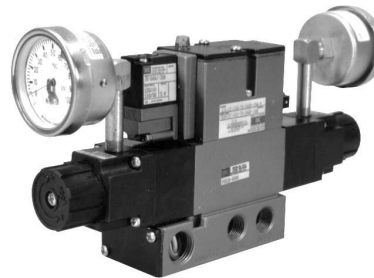

### 2PC-3/8 Remote Mounted

Two position, four way, five ported, single solenoid, spring return, with dual pressure sandwich regulator sub-base mounted, 3/8" NPT

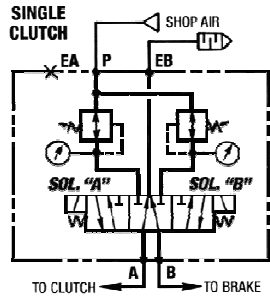

### 2PC-SC-3/8, 2PC-SC-5/8, 2PC-SC-3/4 Single Clutch Remote Mounted

Three position, four way, five ported, center position to exhaust, dual solenoid, spring centered, with dual pressure sandwich regulator sub-base mounted, 3/8" NPT, 5/8" NPT and 3/4" NPT.

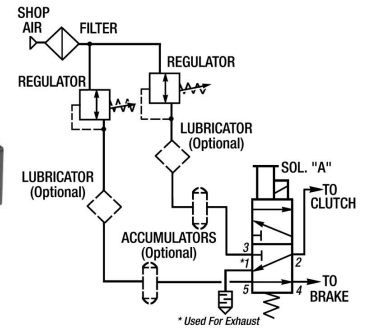
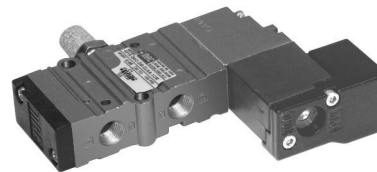

### 2PI-1/8 Manifold Mounted and Remote Mounted "P" Logic Only

Two position, four way, five ported, single solenoid, spring return, 1/8" NPT. *This pneumatic valve set-up requires the use of external pressure regulators. (The Pressure Regulators must be sized to furnish the required torque.)*

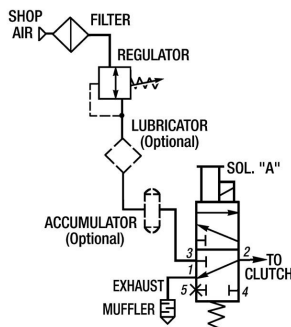
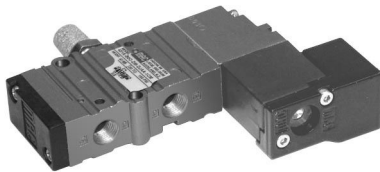

### 2PI-1/8 Manifold Mounted "A" and "C" Logic Only

Two position, four way, five ported, single solenoid, spring return with brake ports plugged, 1/8" NPT. *This pneumatic valve set-up requires the use of external pressure regulators. (The Pressure Regulators must be sized to furnish the required torque.)*

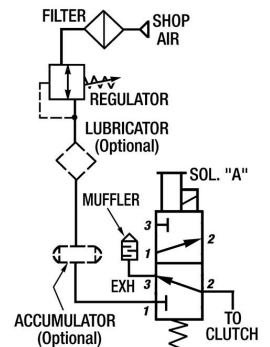
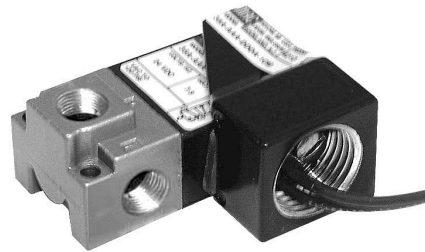

### 1PI-1/8 Remote Mounted "A" and "C" Logic Only

Two position, two way, three ported, single solenoid, spring return, 1/8" NPT. *This pneumatic valve set-up requires the use of external pressure regulators. (The Pressure Regulators must be sized to furnish the required torque.)*



# Pneumatic Control Valves

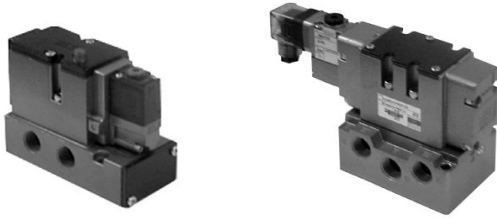

### 2PI-3/8, 2PI-5/8, 2PI-3/4

The 2PI-3/8 Control Valve is used on Sizes 02 to 10 Posidyne Clutch/Brake Units. The Size 11 Posidyne uses a 2PI-5/8 and a Size 20 & 30 Posidyne uses a 2PI-3/4 Control Valve.

**NOTE:** The 2PI-5/8 and 2PI-3/4 Control Valves are furnished with a DIN Connector and 6 Ft. long electrical cable.

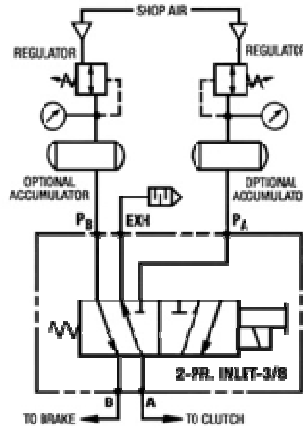

Two position, four way, five ported, single solenoid, spring return, 3/8", 5/8" & 3/4" NPT. This pneumatic valve set-up requires the use of external pressure regulators. (The Pressure Regulators must be sized to furnish the required torque.)

For high cycle applications when a CLPC (Closed Loop Position Control) is used an accumulator is recommended to be installed in the inlet pressure line. (The accumulator must be sized to be 10 x the air required per engagement.)

(See appropriate Specification Charts for the required torque and required air per engagement.)



1PI-BR-1/8

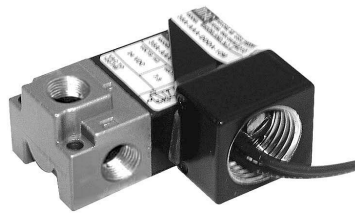

1PI-BR-1/8

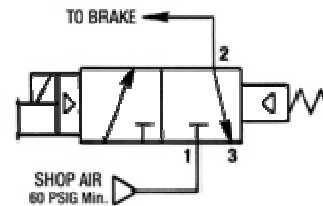

### Motor Brake Application

Two position, Two Way, Three Ported, Single Solenoid, Spring Return, Internal Pilot Operated, Normally Closed, 1/8" or 3/8" NPT Pneumatic Control Valve.

### Valve Specifications:

Ambient Temp. . . 0° F. to 120° F.

Electrical.....120 VAC 60 Hz, Inrush - 14.7 Volt/Amp (.12 Amps), Seal - 10.4 Volt/Amps (.09 Amps)

Coil .....General Purpose Class A Continuous Duty.

Pr. Range .....150 PSI Max.

### Control Valve Logic

	ON	OFF
Solenoid Function	Energized	De-Energized

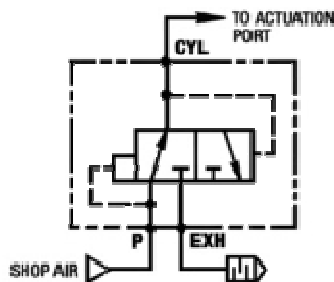

Quick Exhaust Valve (QE-3/8)

The use of Quick Exhaust Valves installed directly at the actuation port of the clutch or brake improves response time, repeatability and final positioning accuracy for most applications. It is recommended that when the control valve is located 10 Ft. or more away from the drive unit this Quick Exhaust Valve is used in each pressure line. This valve is available as part number **QE-3/8**.

### Optional Manifold Mounted Valves

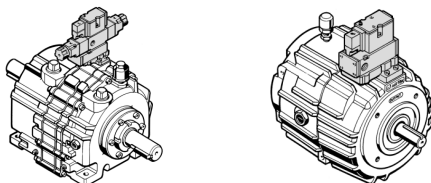

These pneumatic control valves can also be furnished with porting for Manifold Mounting. This allows the control valve to be directly mounted to the drive unit which gives you a compact and efficient drive unit with improved response time. When ordering a **Manifold Mounted Control Valve**, just use the **Ordering System Chart**



# Pneumatic Control Valves—How To Order



**(1) Number of Pressures**

<b>1</b>	=1 Pressure Single Clutch or Brake
<b>2</b>	=2 Pressure Clutch Brake

**(3) Port Size**

<b>A</b>	= 1/8" NPT
<b>B</b>	= 3/8" NPT
<b>C</b>	= 5/8" NPT
<b>D</b>	= 3/4" NPT

**(8) Gauges**

<b>G</b>	Glycerin
<b>D</b>	Dry Type
<b>N</b>	None

**(2) Valve Type**

<b>PC</b>	=Sandwich Regulators (Single Clutch)
<b>PC-SC</b>	=Sandwich Regulators (Single Clutch SCP Logic Only)
<b>PI</b>	=No Regulators, Single Valve
<b>PI-2V</b>	=No Regulators, Dual Valves
<b>PI-Br</b>	=No Regulators (Motor Brake Only)

**(4, 5) Voltage**

<b>1 A</b>	= 115VAC
<b>2 A</b>	= 220 VAC
<b>4 A</b>	= 460 VAC
<b>1 D</b>	= 12 VDC
<b>2 D</b>	= 24 VDC

**(7) Wire Connector**

<b>3BH</b>	=3 Pin BH Mini-Change Connector
<b>4BH</b>	=4 Pin BH Mini-Change Connector
<b>5BH</b>	=5 Pin BH Mini-Change Connector
<b>DIN</b>	=DIN Connector (#11 & #20 Posidyne Only) (Includes 6 Ft. Long Cable.)
<b>MS</b>	=Mil Specifications
<b>N</b>	= None

**(6) Mounting**

<b>L</b>	= Shipped Loose. (Mounted (Mounted and Plumbed by Customer)
<b>M</b>	= Manifold Mounted on Posidyne.
<b>PR</b>	= Pre-Plumbed and Brkt. Mntd.(Right Side Viewing Output Shaft)
<b>PL</b>	= Pre-Plumbed and Brkt. Mntd. (Left Side Viewing Output Shaft)

**NOTES:** All valves Cv = 1.0 Min.; All solenoids are std. 120 VAC continuous duty rated for 60 Hz operation.  
 Inrush Current (amps) ..... .11  
 Holding Current (amps) ..... .08  
 Time to Energize (sec.)..... .011  
 Time to de-energize (sec.)..... .016  
 DC and hazardous location solenoids are available.  
 Consult factory.



# Pneumatic Control Valves—Installation & Design Suggestions

## Mounting Locations

The internal piston volumes of Force Control Clutch/Brake and Brake Products are quite low. The control valves should be located as close as possible to the unit, as this directly affects the response time and consistency. Many of the products have manifold mounted valves available, which is the best arrangement because it eliminates the plumbing between the valve and the Force Control unit.

## Air Line Sizes and Fittings

The optimum air line size is 3/8" for sizes 01 through 11 Posidyne clutch/brakes and 056 through 280 Posistop brakes. The size 20 Posidyne clutch/brake and size 320 Posistop brake should have 1/2" air lines. The fewest number of fittings should be used and all fittings should be maximum flow type. A tee and pressure gauge located near the actuation port is often helpful for troubleshooting.

## Accumulators

In High Cycle Applications, for the best response and consistency, accumulators should be used for the clutch and one for the brake on Posidyne clutch/brakes. This will maintain a constant pressure to the unit. Regulators should be located on the inlet to the accumulators.

## Air Line Connections and Air Supply

Both top and bottom porting is supplied in many of the models. Whenever possible, bottom porting is recommended to purge any contamination from the piston chamber. The air supply should be dry and free of all contamination. The cleaner the air is the longer the control valves and drive unit will last. Lubricated air will make the control valves last longer but... too much oil will fill up the piston chamber with oil and cause sluggish action of the piston. **No oil is better than too much oil. Lubricated oil is not necessary for our drive units.**

## High Speed - High Accuracy Applications

For High Speed and High Accuracy Applications the system should be equipped with a consistent air supply, accumulators of the proper size (Consult Force Control for assistance), with regulators on the input, large hoses to the valve and manifold mounted valve, if possible. If not manifold mounted, the valve should be located as close as possible and quick exhaust valves should be used at the actuation port.

## Electronic Controls

Many of the positioning problems associated with the clutch/brake can be traced to the control system. PLC controls often include scan time delays depending on the speed of the control and number of lines of code used. High-speed cards may be required. The type of limit switches can also cause position error. **Force Control** has developed the **CLPC** Closed Loop Positioning Control which eliminates scan time problems. The **CLPC** is closed loop to correct positioning errors and will compensate for cold start to hot run phase shift, as well as adjustment for changing speeds, loads and other variables in the drive system. (See [forcecontrol.com/products/clpc](http://forcecontrol.com/products/clpc) for further information on the **CLPC** series controls.)

## NOTES:

- All valves Cv = 1.0 Min.
- Inrush Current (amps) \_\_\_\_\_0.11
- Holding Current (amps) \_\_\_\_\_8
- AC solenoids are std. 120 VAC continuous
- DC solenoids are available in 24 VDC and 90
- Time to Energize (sec.) \_\_\_\_0.011
- Time to de-energize (sec.) \_\_\_\_0.016
- Hazardous location solenoids are available.