

# Section 10 Pneumatic Control Valves

Force Control's family of Oil Shear Clutch and Brake Products is most often actuated by a Pneumatic Control Valve. Torque control of the units is accomplished by adjusting the actuation pressure. To aid the designer in the selection specification of the correct control circuit the charts below have been provided. During the selection process of the **Posidyne** or **Posistop** a particular logic type was decided upon. Based on the logic type of your unit find the correct control valve model number indicated in the appropriate chart.

Posidyne Clutch/Brake				
Logic	Valve Model Number			
	Standard Posidyne Clutch/Brake			X Class Posidyne Clutch/Brake
	Sizes 02 to 10	Size 11	Sizes 20 & 30	
S	2PC-3/8 or 2PI-3/8	2PI-5/8	2PI-3/4	N/A
SA	2PC-3/8 or 2PI-3/8	2PI-5/8	2PI-3/4	N/A
A	1PC-3/8 or 2PI-3/8*	2PI-5/8*	2PI-3/4*	1PI-1/8 or 2PI-1/8*
B	1PC-3/8 or 2PI-3/8*	2PI-5/8*	2PI-3/4*	N/A
C	1PC-3/8 or 2PI-3/8*	2PI-5/8*	2PI-3/4*	1PI-1/8 or 2PI-1/8*
SCP	2PC-SC-3/8	2PC-SC-5/8	2PC-SC-3/4	N/A
P	2PC-3/8 or 2PI-3/8	2PI-5/8	2PI-3/4	2PI-1/8

N/A - Not Available

Posistop Motor Brake		
Logic	Valve Model No.	
	MB Series Brake	XB Class Brake
S	1PI-Br-3/8	1PI-Br-1/8
A	or 1PC-3/8	or 1PI-1/8
B		

\* - When using a Model 2PI Control Valve for A, B or C Logic Single Clutch Unit, the brake port is not used and must be plugged.

## 1PC-3/8

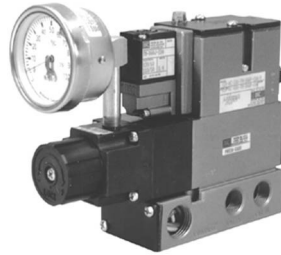

See Optional Manifold Mounting on page 10.3.

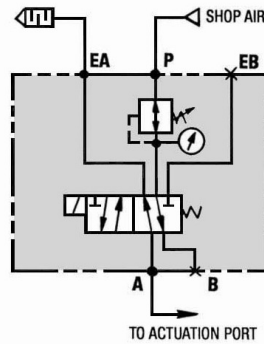

Two position, four way, five ported, single solenoid, spring return, with single pressure sandwich regulator sub-base mounted, 3/8" NPT.

## 2PC-3/8

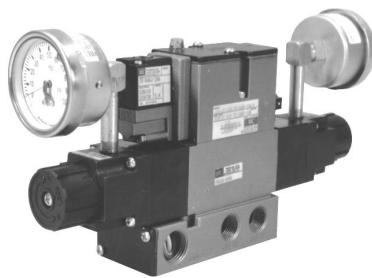

See Optional Manifold Mounting on page 10.3.

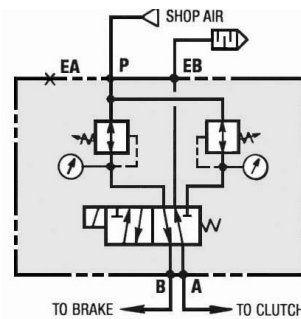

Two position, four way, five ported, single solenoid, spring return, with dual pressure sandwich regulator sub-base mounted, 3/8" NPT.

## 2PC-SC-3/8 2PC-SC-5/8 2PC-SC-3/4

(Single Clutch)

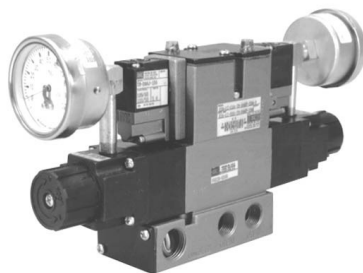

See Optional Manifold Mounting on page 10.3.

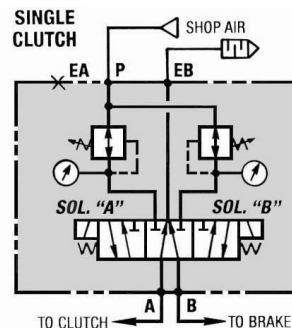

Three position, four way, five ported, center position to exhaust, dual solenoid, spring centered, with dual pressure sandwich regulator sub-base mounted, 3/8" NPT, 5/8" NPT and 3/4" NPT.

2PI-1/8  
Manifold  
Mounted  
and  
Remote  
Mounted

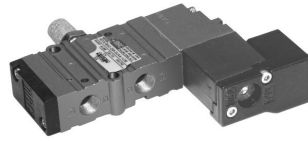

“P” Logic Only

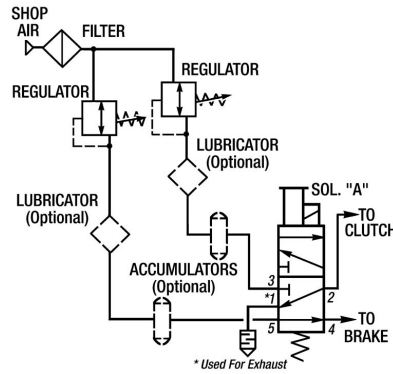

Two position, four way, five ported, single solenoid, spring return, 1/8” NPT.

This pneumatic valve set-up requires the use of external pressure regulators. *(The Pressure Regulators must be sized to furnish the required torque.)*

2PI-1/8  
Manifold  
Mounted



“A” and “C”  
Logic Only

Brake Ports  
Plugged

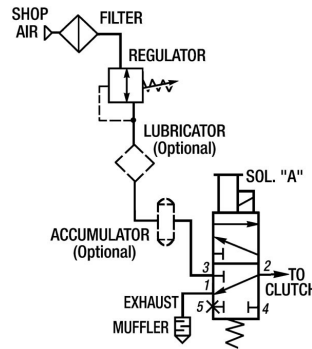

Two position, four way, five ported, single solenoid, spring return with brake ports plugged, 1/8” NPT.

This pneumatic valve set-up requires the use of external pressure regulators. *(The Pressure Regulators must be sized to furnish the required torque.)*

10

1PI-1/8  
Remote  
Mounted

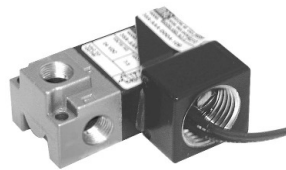

“A” and “C”  
Logic Only

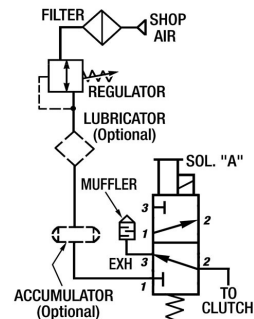

Two position, two way, three ported, single solenoid, spring return, 1/8” NPT.

This pneumatic valve set-up requires the use of external pressure regulators. *(The Pressure Regulators must be sized to furnish the required torque.)*

2PI-3/8  
(2 Pr. Inlet-3/8)



2PI-5/8  
(2 Pr. Inlet-5/8)

2PI-3/4  
(2 Pr. Inlet-3/4)



See Optional Manifold Mounting on page 10.3.

The 2PI-3/8 Control Valve is used on Sizes 02 to 10 Posidyne Clutch/Brake Units. The Size 11 Posidyne uses a 2PI-5/8 and a Size 20 & 30 Posidyne uses a 2PI-3/4 Control Valve.

**NOTE:** The 2PI-5/8 and 2PI-3/4 Control Valves are furnished with a DIN Connector and 6 Ft. long electrical cable.

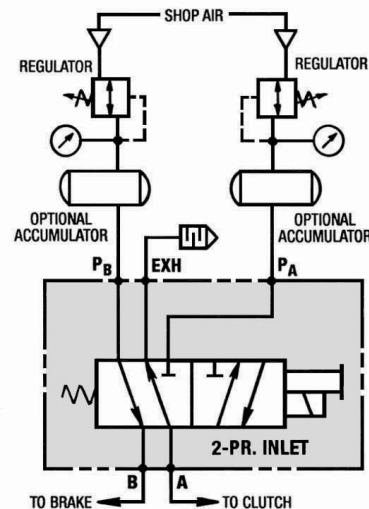

Two position, four way, five ported, single solenoid, spring return, 3/8”, 5/8” & 3/4” NPT.

This pneumatic valve set-up requires the use of external pressure regulators. *(The Pressure Regulators must be sized to furnish the required torque.)*

For high cycle applications when a **CLPC** (Closed Loop Position Control) is used an accumulator is recommended to be installed in the inlet pressure line. *(The accumulator must be sized to be 10 x the air required per engagement.)*

1PI-Br-1/8

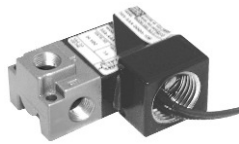

1PI-Br-3/8

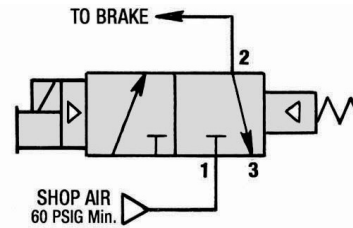

Control Valve Logic

	RUN	STOP
Solenoid Function	ON Energized	OFF De-Energized

Motor Brake Application

Two position, Two Way, Three Ported, Single Solenoid, Spring Return, Internal Pilot Operated, Normally Closed, 1/8" or 3/8" NPT Pneumatic Control Valve.

Valve Specifications:

Ambient Temp. 0° F. to 120° F.

Electrical ..... 120 VAC  
60 Hz

Inrush - 14.7 Volt/Amp  
(.12 Amps)

Seal - 10.4 Volt/Amps  
(.09 Amps)

Coil ..... General Purpose Class A  
Continuous Duty.

Pr. Range.....150 PSI Max.

Optional Manifold Mounted Control Valve

1PI-1/8, 1PI-3/8, 2PI-1/8, 2PC-3/8, 2PI-1/8, 2PI-3/8, 2PI-5/8, 2PI-3/4 and 2PI-2-3/8 Control Valves

These pneumatic control valves can also be furnished with porting for Manifold Mounting. This allows the control valve to be directly mounted to the drive unit which gives you a **compact and efficient drive unit with improved response time.**

When ordering a **Manifold Mounted Control Valve**, just use the **Ordering System Chart** and specify "Manifold Mounted" in the appropriate block.



The example shown is a Posidyne X Class Clutch/Brake Unit with a 2PI-1/8 Manifold Mounted Control Valve.

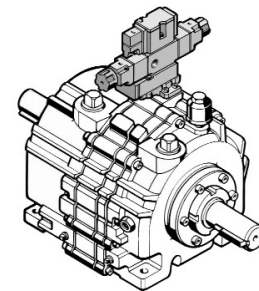

The example shown is a 03 Posidyne Clutch/Brake Unit with a 2-PC-3/8 Manifold Mounted Control Valve.

Quick Exhaust Valve (QE-3/8)

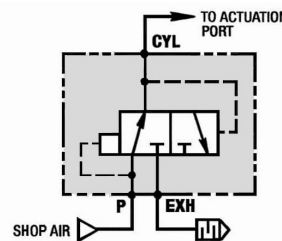
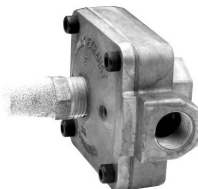

The use of Quick Exhaust Valves installed directly at the actuation port of the clutch or brake improves response time, repeatability and final positioning accuracy for most applications. It is recommended that when the control valve is located 10 Ft. or more away from the drive unit this Quick Exhaust Valve is used in each pressure line. This valve is available as part number QE-3/8.

## Installation and Design Suggestions

### Mounting Locations

The internal piston volumes of Force Control Clutch/Brake and Brake Products are quite low. The control valves should be located as close as possible to the unit, as this directly affects the response time and consistency. Many of the products have manifold mounted valves available, which is the best arrangement because it eliminates the plumbing between the valve and the Force Control unit.

### Air Line Sizes and Fittings

The optimum air line size is 3/8" for sizes 01 through 11 *Posidyne* clutch/brakes and 056 through 280 *Posistop* brakes. The size 20 *Posidyne* clutch/brake and size 320 *Posistop* brake should have 1/2" air lines. The fewest number of fittings should be used and all fittings should be maximum flow type. A tee and pressure gauge located near the actuation port is often helpful for troubleshooting.

### Accumulators

In High Cycle Applications, for the best response and consistency, accumulators should be used for the clutch and one for the brake on *Posidyne* clutch/brakes. This will maintain a constant pressure to the unit. Regulators should be located on the inlet to the accumulators.

### Air Line Connections and Air Supply

Both top and bottom porting is supplied in many of the models. Whenever possible, bottom porting is recommended to purge any contamination from the piston chamber.

The air supply should be dry and free of all contamination. The cleaner the air is the longer the control valves and drive unit will last. Lubricated air will make the control valves last longer but... too much oil will fill the piston chamber with oil and cause sluggish action of the piston.

### High Speed - High Accuracy Applications

For High Speed and High Accuracy Applications the system should be equipped with a consistent air supply, accumulators of the proper size

### Electronic Controls

Many of the positioning problems associated with the clutch/brake can be traced to the control system. PLC controls often include scan time delays depending on the speed of the control and number of lines of code used. High-speed cards may be required. The type of limit switches can also cause position error.

**Force Control** has developed the **CLPC** Closed Loop Positioning Control which eliminates scan time problems. The **CLPC** will correct positioning errors and compensate for cold start to hot run shifts, as well as adjustment for changing speeds, loads and other variables .

NOTES: All valves Cv = 1.0 Min.; All solenoids are std. 120 VAC continuous duty rated for 60 Hz operation.	Inrush Current (amps).....	.11	Time to de-energize (sec.).....	.016
	Holding Current (amps).....	.08	DC and hazardous location solenoids are available.	
	Time to Energize (sec.).....	.011	Consult factory.	

## How to order your Pneumatic Control Valve...

### Ordering System Chart

Example: V-2-PC-A-1A-M-4BH-G



10

#### Number of Pressures (1)

- 1 = 1 Pressure  
*(Single Clutch or Brake)*
- 2 = 2 Pressure  
*(Single Clutch & Brake)*

#### Valve Type (2)

- PC = Sandwich Regulators *(Single Clutch)*
- PC-SC = Sandwich Regulators *(Single Clutch SCP Logic Only)*
- PI = No Regulators, Single Valve
- PI-2V = No Regulators, Dual Valves
- PI-Br = No Regulators *(Motor Brake Only)*

#### Port Size (3)

- A = 1/8" NPT
- B = 3/8" NPT
- C = 5/8" NPT
- D = 3/4" NPT

#### Voltage (4,5)

- |   |   |           |
|---|---|-----------|
| 1 | A | = 115VAC  |
| 2 | A | = 220 VAC |
| 4 | A | = 460 VAC |
| 1 | D | = 12 VDC  |
| 2 | D | = 24 VDC  |

#### Mounting (6)

- L = Shipped Loose. *(Mounted and Plumbed by Customer)*
- M = Manifold Mounted on *Posidyne.*
- PR = Pre-Plumbed and Brkt. Mntd. *(Right Side Viewing Output Shaft)*
- PL = Pre-Plumbed and Brkt. Mntd. *(Left Side Viewing Output Shaft)*

#### Wire Connector (7)

- 3BH = 3 Pin BH Mini-Change Connector.
- 4BH = 4 Pin BH Mini-Change Connector.
- 5BH = 5 Pin BH Mini-Change Connector.
- DIN = DIN Connector (#11 & #20 *Posidyne* Only) *(Includes 6 Ft. Long Cable.)*
- MS = Mil Specifications
- N = None

#### Gauges (8)

- G = Glycerin Type
- D = Dry Type
- N = None